

TDG 1540

FITTING INSTRUCTION / INSTRUCTION DE MONTAGE / EINBAUANLEITUNG /
ISTRUZIONI PER L'USO / INSTRUCCIONES DE MONTAJE / MONTAGEHANDLEIDING



SEAT ATECA PANORAMIC

DOG GUARD / GRILLE PROTECTRICE POUR CHIEN / HUNDEGITTER /
RIPARO PER CANI / DEFENSA PARA PERROS / HONDEREK

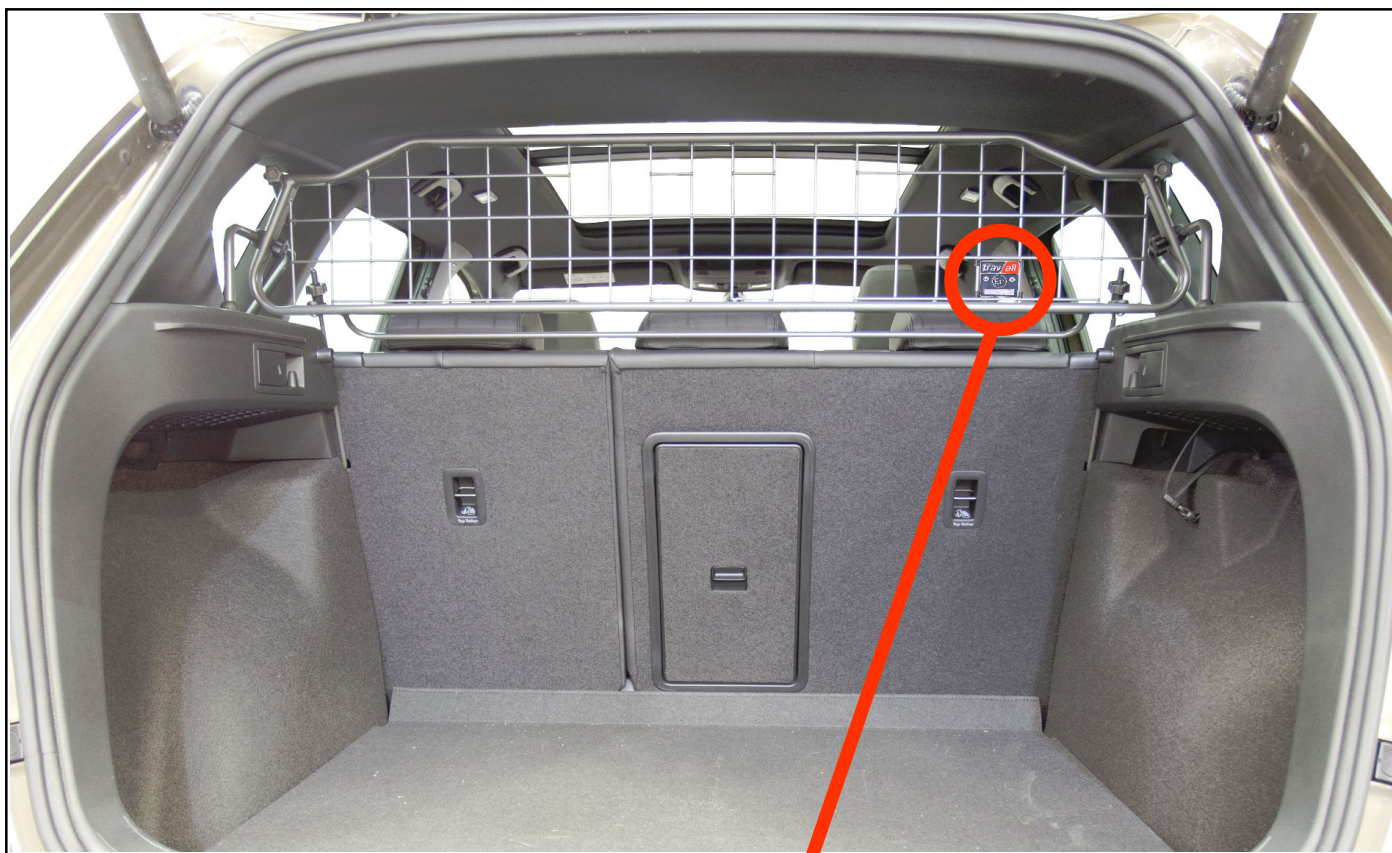

- E Mark Badge must be visible from the luggage area of the vehicle.
Le badge de la marque E doit être visible depuis le coffre à bagages du véhicule.
Il contrassegno E deve essere visibile dal vano bagagli del veicolo.
El distintivo de la marca E debe ser visible desde el maletero del vehículo.
- Das E-Prüfzeichen muss vom Gepäckraum des Fahrzeugs aus sichtbar sein.

SEAT ATECA PANORAMIC

DOG GUARD / GRILLE PROTECTRICE POUR CHIEN / HUNDEGITTER /
RIPARO PER CANI / DEFENSA PARA PERROS / HONDEREK

- This product is suitable for installation and use only in the vehicle stated.
- Please ensure you correctly follow the installation method described in this document on every use.
- We recommend you do not stack objects higher than the top of the seat in the luggage area and where possible secured using appropriate restraint systems.
- It is important to use this partitioning system when transporting objects in the luggage area.
- If this partitioning system is damaged in any way, it should be replaced.

GB

- Ce produit convient uniquement à l'installation et à l'utilisation dans le véhicule indiqué.
- Veuillez à suivre correctement la méthode d'installation décrite dans ce document à chaque utilisation.
- Nous vous recommandons de ne pas empiler d'objets plus hauts que le haut du siège dans le compartiment à bagages et, dans la mesure du possible, de les fixer à l'aide de systèmes de retenue appropriés.
- Il est important d'utiliser le système de cloisonnement lorsque vous transportez des objets dans le coffre à bagages.
- Si le système de séparation est endommagé de quelque manière que ce soit, il doit être remplacé.

F

- Questo prodotto è adatto all'installazione e all'uso solo nel veicolo indicato.
- Assicurarsi di seguire correttamente il metodo di installazione descritto in questo documento ad ogni utilizzo.
- Si raccomanda di non impilare oggetti più alti della parte superiore del sedile nel vano bagagli e, se possibile, di fissarli con sistemi di ritenuta adeguati.
- È importante utilizzare il sistema divisorio quando si trasportano oggetti nel bagagliaio.
- Se il sistema divisorio è danneggiato in qualche modo, deve essere sostituito.

IT

- Este producto es apto para su instalación y uso únicamente en el vehículo indicado.
- Asegúrese de seguir correctamente el método de instalación descrito en este documento en cada uso.
- Le recomendamos que no apile objetos más altos que la parte superior del asiento en el maletero y siempre que sea posible asegurarlos mediante sistemas de retención adecuados.
- Es importante utilizar el sistema de separación al transportar objetos en el maletero.
- Si el sistema de separación está dañado de algún modo, debe sustituirse.

ES

- Dieses Produkt ist nur für den Einbau und die Verwendung in dem angegebenen Fahrzeug geeignet.
- Stellen Sie sicher, dass Sie die in diesem Dokument beschriebene Einbaumethode bei jeder Verwendung korrekt befolgen.
- Wir empfehlen Ihnen, im Gepäckraum keine Gegenstände zu stapeln, die höher als die Oberkante des Sitzes sind und wenn möglich mit geeigneten Rückhaltesystemen zu sichern.
- Es ist wichtig, das Trennwandsystem zu verwenden, wenn Sie Gegenstände im Gepäckraum transportieren.
- Wenn das Trennwandsystem in irgendeiner Weise beschädigt ist, muss es ersetzt werden.

D

TDG 1540

FITTING INSTRUCTION / INSTRUCTION DE MONTAGE / EINBAUANLEITUNG /
ISTRUZIONI PER L'USO / INSTRUCCIONES DE MONTAJE / MONTAGEHANDLEIDING



SEAT ATECA PANORAMIC

DOG GUARD / GRILLE PROTECTRICE POUR CHIEN / HUNDEGITTER /
RIPARO PER CANI / DEFENSA PARA PERROS / HONDEREK

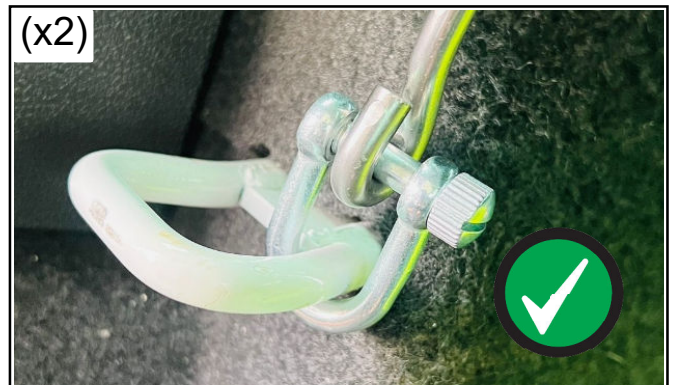
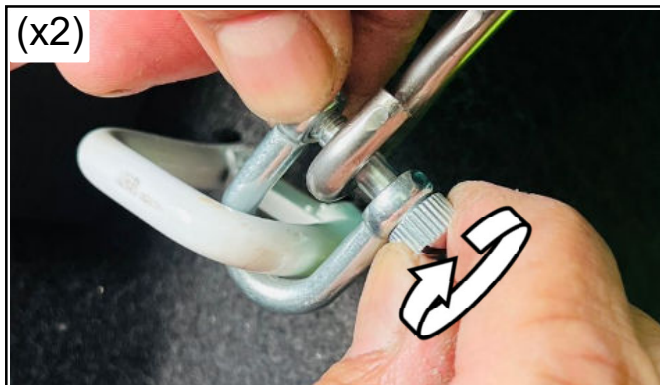
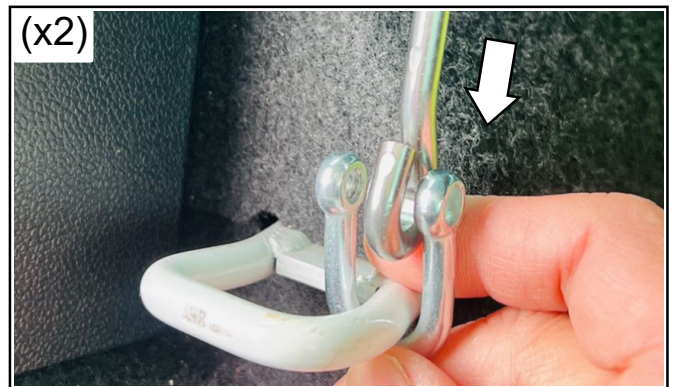
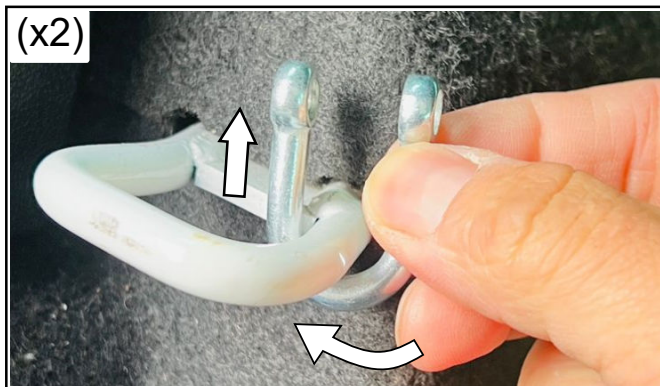
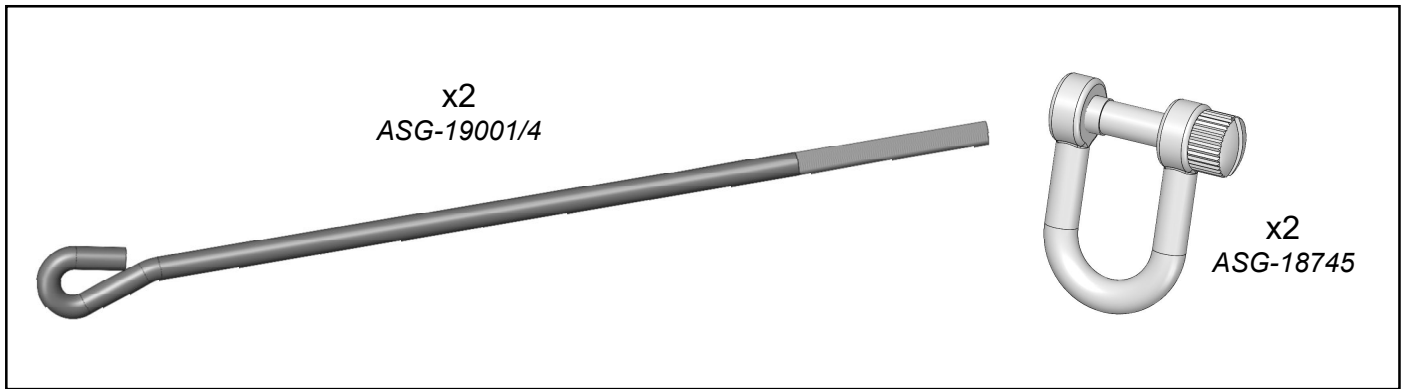
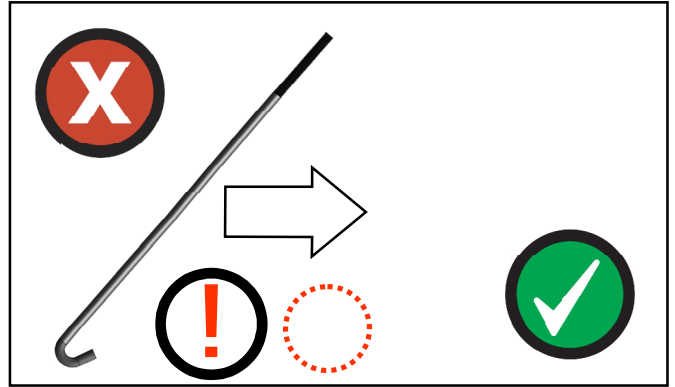

TDG 1540

FITTING INSTRUCTION / INSTRUCTION DE MONTAGE / EINBAUANLEITUNG /
ISTRUZIONI PER L'USO / INSTRUCCIONES DE MONTAJE / MONTAGEHANDLEIDING



SEAT ATECA PANORAMIC

DOG GUARD / GRILLE PROTECTRICE POUR CHIEN / HUNDEGITTER /
RIPARO PER CANI / DEFENSA PARA PERROS / HONDEREK

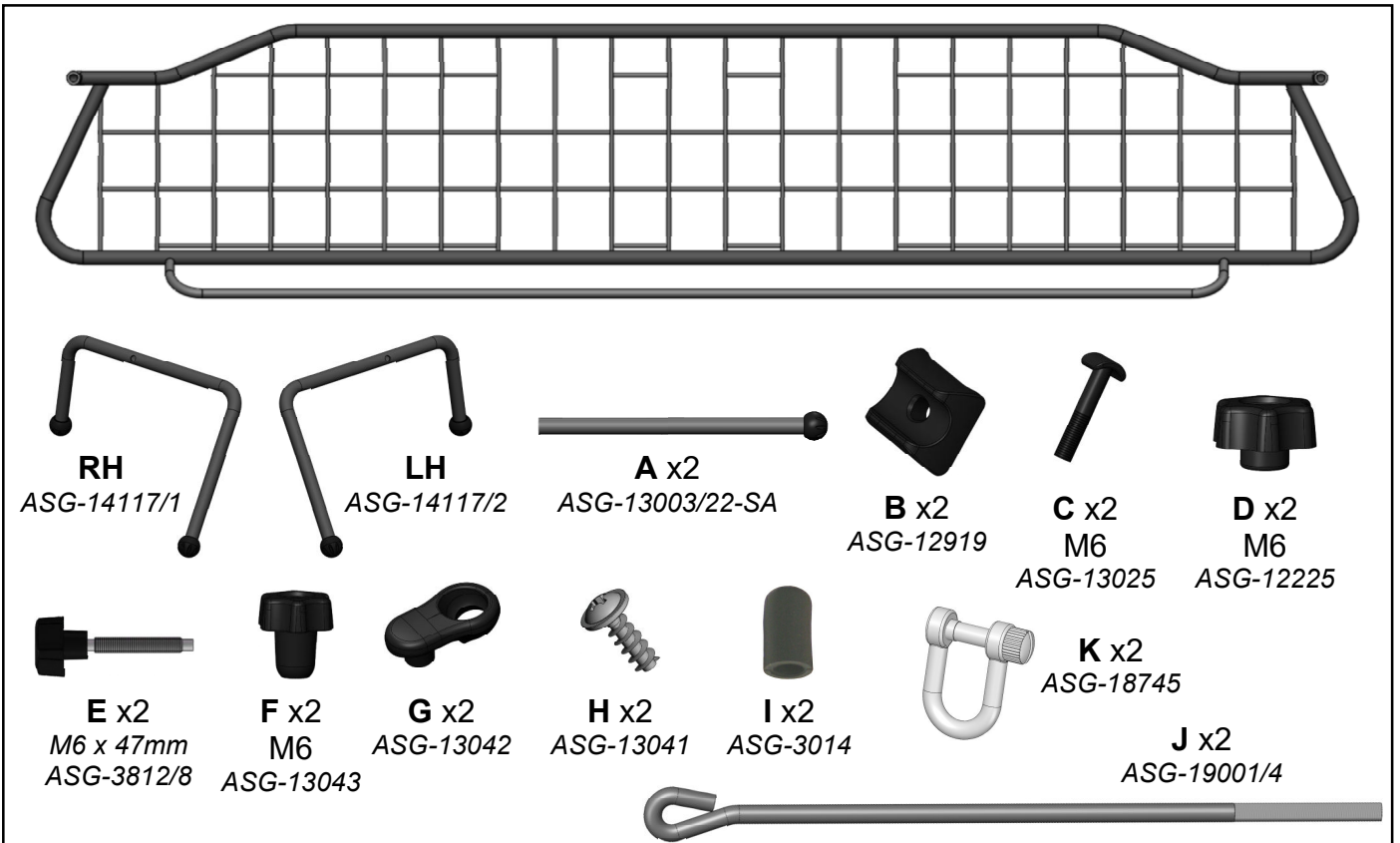

TDG 1540

FITTING INSTRUCTION / INSTRUCTION DE MONTAGE / EINBAUANLEITUNG /
ISTRUZIONI PER L'USO / INSTRUCCIONES DE MONTAJE / MONTAGEHANDLEIDUNG



SEAT ATECA PANORAMIC

DOG GUARD / GRILLE PROTECTRICE POUR CHIEN / HUNDEGITTER /
RIPARO PER CANI / DEFENSA PARA PERROS / HONDEREK

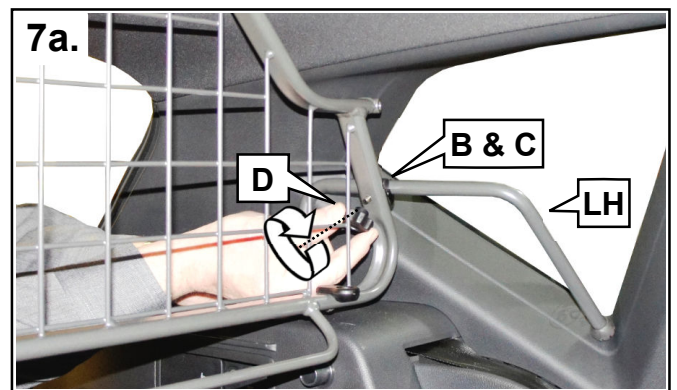
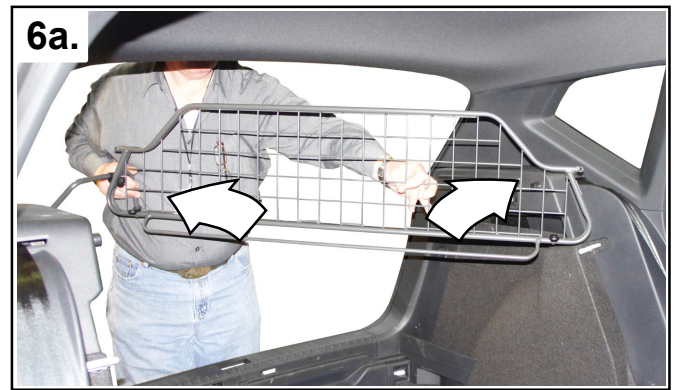
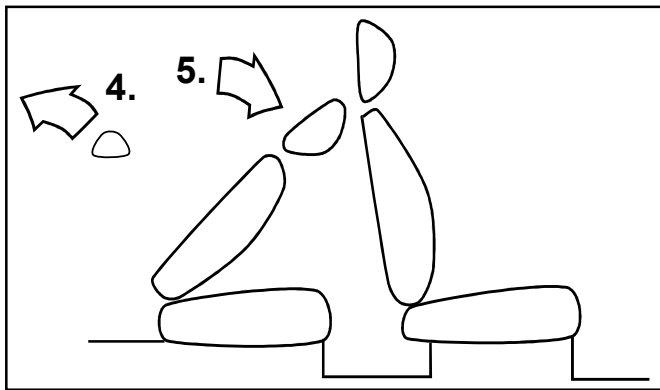
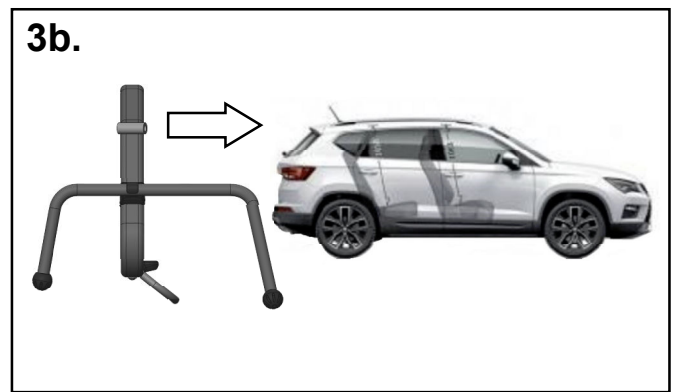
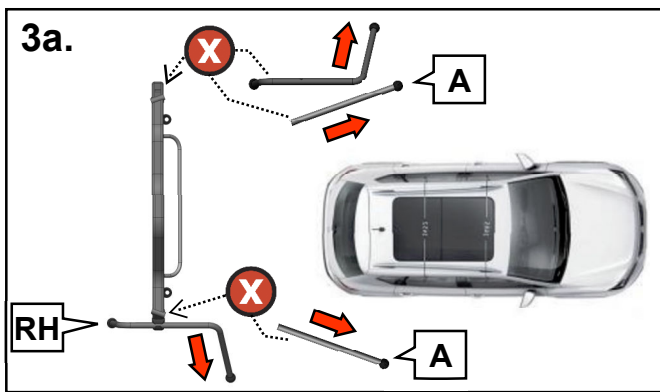
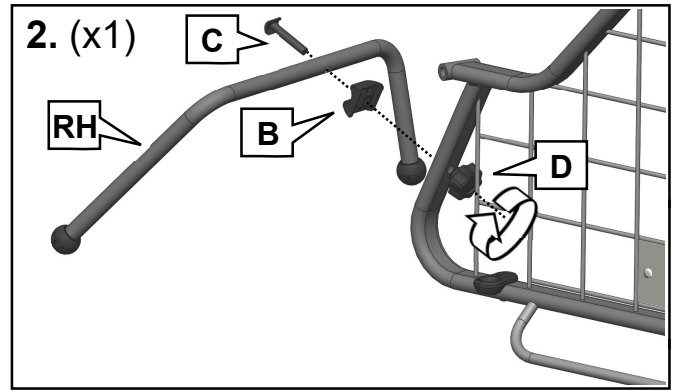
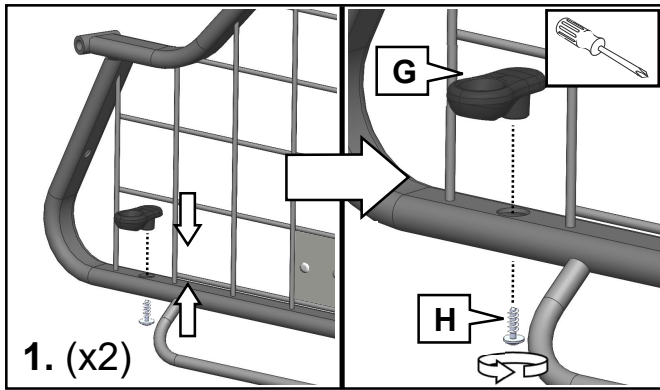

TDG 1540

FITTING INSTRUCTION / INSTRUCTION DE MONTAGE / EINBAUANLEITUNG /
ISTRUZIONI PER L'USO / INSTRUCCIONES DE MONTAJE / MONTAGEHANDLEIDUNG



SEAT ATECA PANORAMIC

DOG GUARD / GRILLE PROTECTRICE POUR CHIEN / HUNDEGITTER /
RIPARO PER CANI / DEFENSA PARA PERROS / HONDEREK

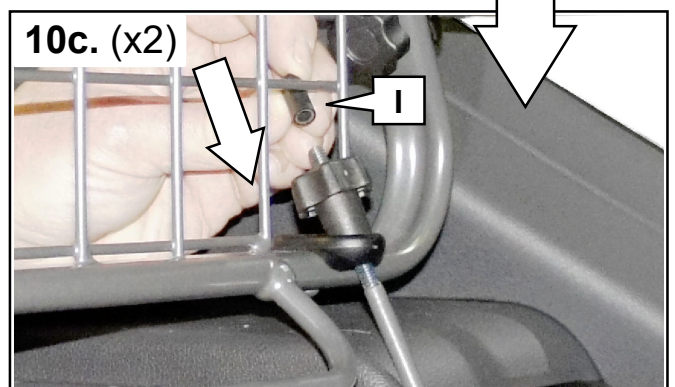
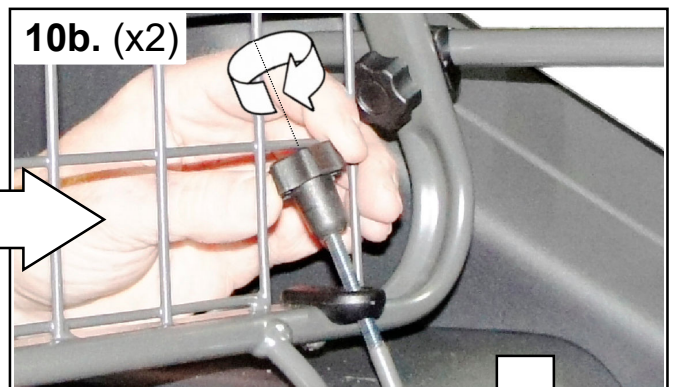
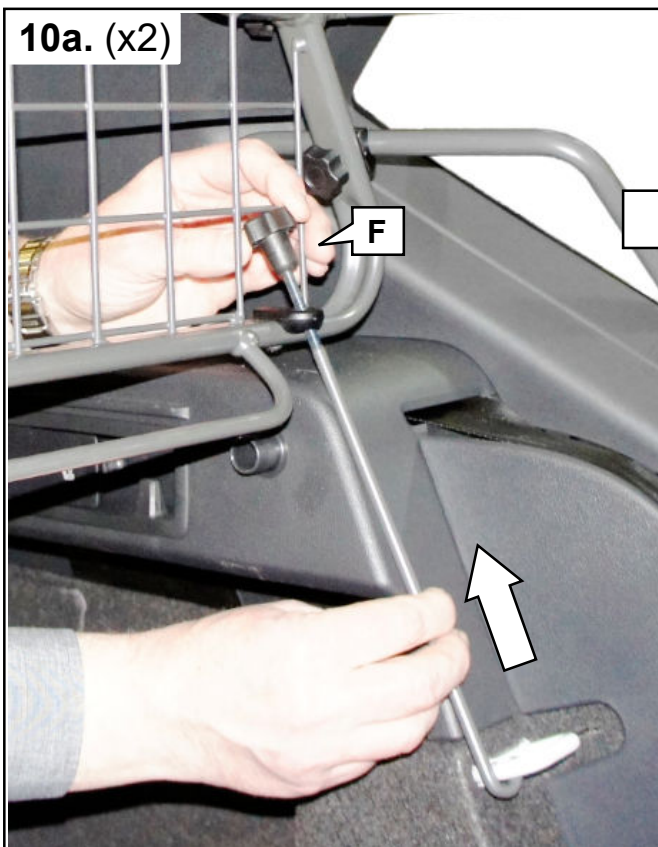
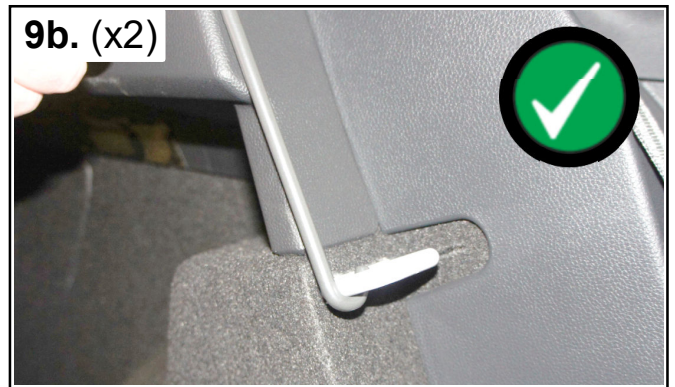
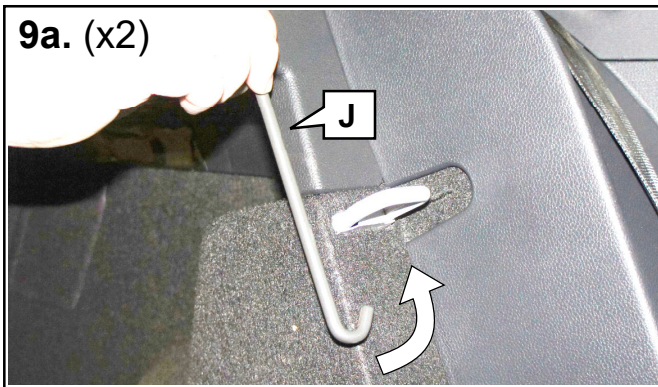
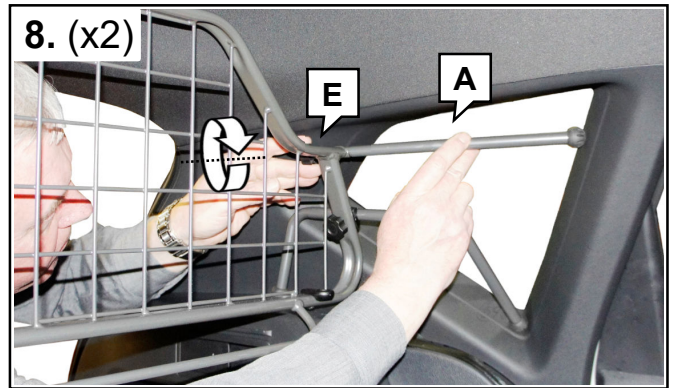
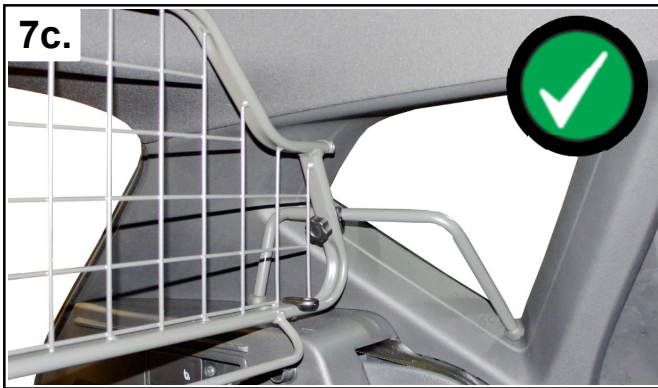

TDG 1540

FITTING INSTRUCTION / INSTRUCTION DE MONTAGE / EINBAUANLEITUNG /
ISTRUZIONI PER L'USO / INSTRUCCIONES DE MONTAJE / MONTAGEHANDLEIDUNG



SEAT ATECA PANORAMIC

DOG GUARD / GRILLE PROTECTRICE POUR CHIEN / HUNDEGITTER /
RIPARO PER CANI / DEFENSA PARA PERROS / HONDEREK

